

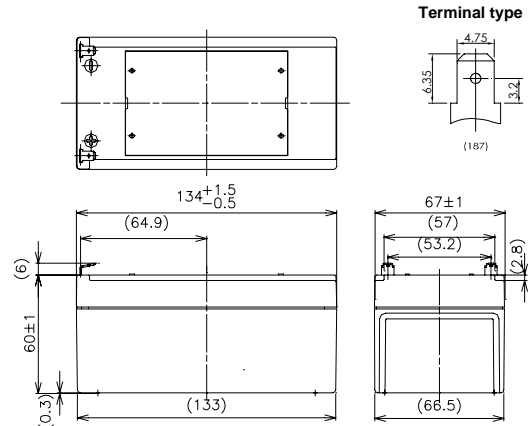

※Contents indicated (including the recycle marking, etc) are subject to change without notice.

### ■Dimensions(mm)



Battery case resin: standard(UL94HB)

### ■Specifications

Nominal Voltage		12V
Rated Capacity(20HR)		3.4Ah
Dimensions	Length	134 mm
	Width	67 mm
	Height	60 mm
	Total height	66 mm
Approx. Mass		1.15 kg
Terminal		Faston 187

### ■Characteristics

Capacity (25 °C)	20 hour rate	3.4Ah
	10 hour rate	3.0Ah
	3 hour rate	2.7Ah
	1 hour rate	2.3Ah
Internal Resistance (25 °C)	Fully charged battery	50 mΩ
Temperature Dependency of Capacity (20 hour rate)	40 °C	102%
	25 °C	100%
	0 °C	85%
	-15 °C	65%
Self Discharge (25 °C)	After 3 months	91%
	After 6 months	82%
	After 12 months	64%

### ■Duration of discharge vs. discharge current

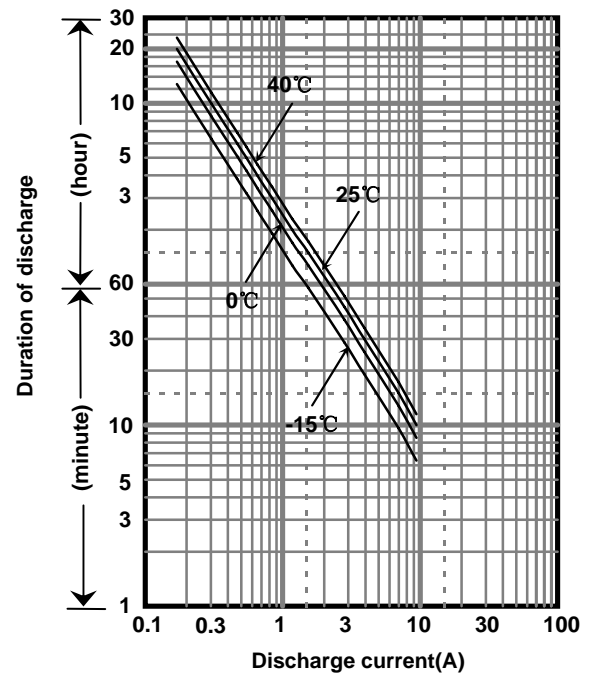

### ■Watt Table(25°C)

(Wattage/Battery)

Cut-off V	3min	5min	10min	15min	20min	30min	45min	1h	1.5h	2h	3h	4h	5h	6h	10h	20h
9.6V	204	161	105	80.4	67.4	50.3	35.5	28.4	19.6	15.0	11.3	8.63	7.13	5.80	3.81	2.06
9.9V	190	151	103	79.8	66.3	49.7	35.3	28.1	19.2	14.9	11.2	8.58	7.07	5.78	3.80	2.05
10.2V	175	142	100	78.2	65.2	49.2	34.9	27.8	18.8	14.5	11.1	8.52	7.01	5.73	3.76	2.05
10.5V	155	127	93.1	72.8	61.9	48.1	34.4	27.3	18.4	14.0	11.0	8.49	6.96	5.66	3.74	2.04
10.8V	131	112	83.0	67.9	60.3	46.4	33.8	26.7	17.8	13.4	10.7	8.46	6.79	5.66	3.68	1.98

### ■Ampere Table(25°C)

(Ampere/Battery)

Cut-off V	3min	5min	10min	15min	20min	30min	45min	1h	1.5h	2h	3h	4h	5h	6h	10h	20h
9.6V	18.4	14.4	9.40	6.99	5.81	4.30	3.02	2.41	1.66	1.26	0.949	0.722	0.595	0.484	0.318	0.171
9.9V	17.0	13.6	9.21	6.94	5.71	4.25	3.00	2.39	1.62	1.24	0.945	0.718	0.590	0.482	0.316	0.171
10.2V	15.7	12.7	8.97	6.80	5.62	4.20	2.97	2.36	1.59	1.22	0.935	0.713	0.586	0.478	0.313	0.170
10.5V	14.0	11.4	8.31	6.33	5.34	4.11	2.93	2.31	1.56	1.18	0.921	0.710	0.581	0.475	0.312	0.170
10.8V	11.8	10.1	7.41	5.90	5.19	3.97	2.88	2.27	1.51	1.13	0.897	0.708	0.567	0.472	0.307	0.165

All mentioned values are average values

**Charging Method (25°C)**

Cycle use	Control voltage: 14.5-14.9V Initial current: 1.36A or smaller
-----------	--

**Cut off voltage**

Discharge current	0.170A-0.680A	0.680A-1.70A	1.70A-3.40A	3.40A-6.80A	6.80A-10.2A
Cut off voltage(V)	10.5	10.2	9.9	9.3	8.7

**Cycle life vs. Depth of discharge**

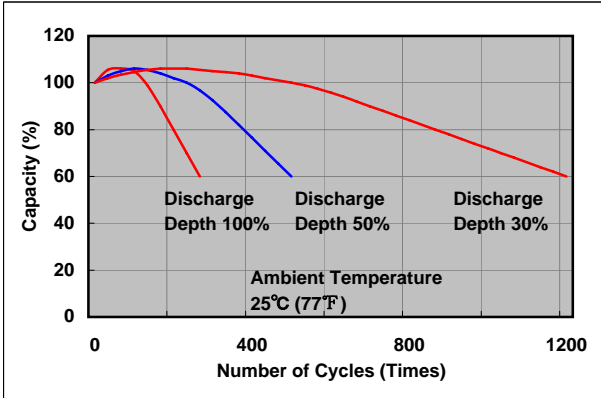

**Residual capacity test result**

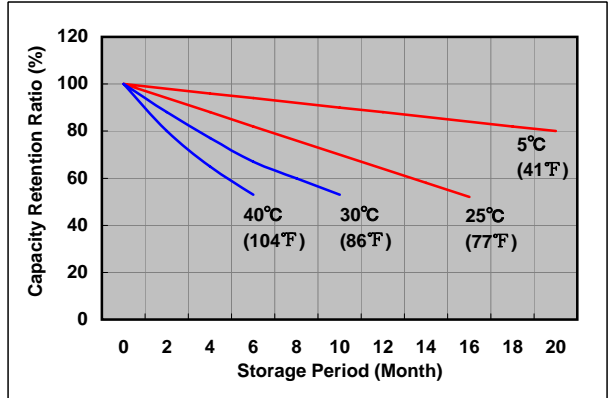

**Constant-voltage constant-current charge characteristics for Cycle use**

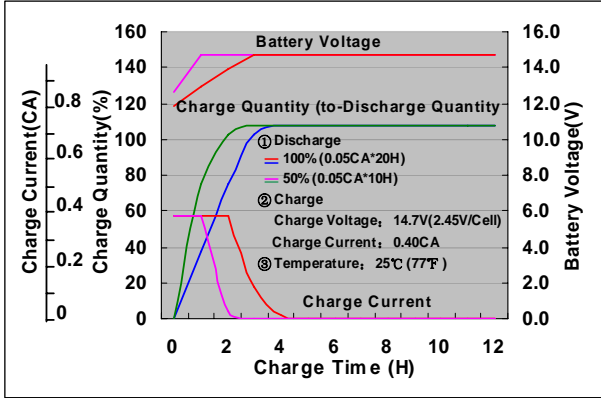

**Discharge capacity by temperature and by discharge current**

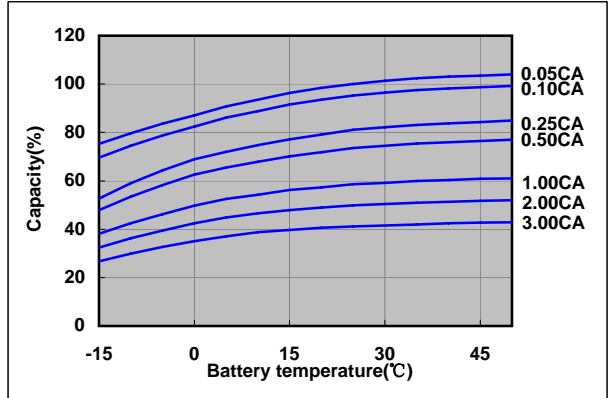

**Discharge characteristics(25°C)**

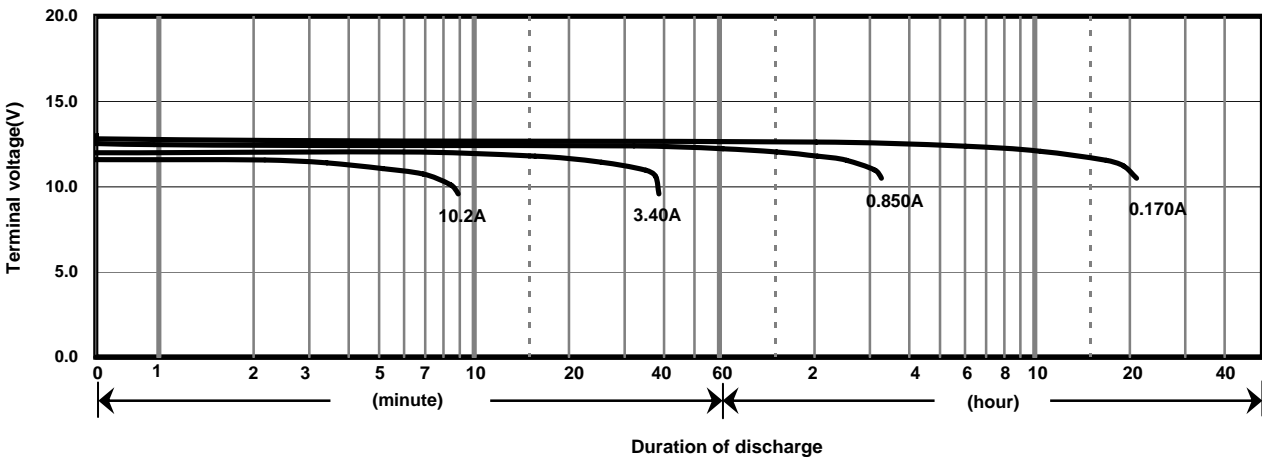

**Caution**

Due to the potential energy stored in the batteries, Please read 《Precautions for handling the Rechargeable Valve Regulated Lead Acid Batteries》 before using batteries. If improper handling or use of the batteries without understanding 《Precautions for handling the Rechargeable Valve Regulated Lead Acid Batteries》 may result in bodily injury caused by electrolyte leakage, heat generation, or explosion.

**Panasonic Storage Battery (Shenyang) Co., Ltd**

NO. 51 Kunminghu Street, Shenyang Economic & Technical Development Zone, 110141 China  
Tel: 86 24 25818921  
Fax: 86 24 62786318  
Website: <http://www.panasonicbattery.cn>

2010.11