

For standby power supplies  
 Expected trickle life: 6 years at 25°C  
 10 years at 20°C

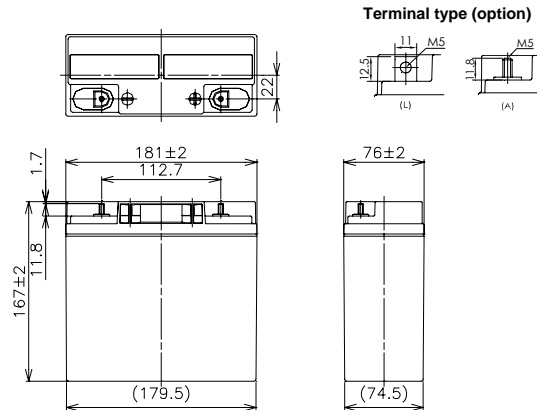

※Contents indicated (including the recycle marking, etc) are subject to change without notice.

### ■Dimensions(mm)



Battery case resin: Flame-retardant (UL94V-0)

### ■Specifications

Nominal Voltage	12V	
Rated Capacity(20HR)	20Ah	
Dimensions	Length	181 mm
	Width	76 mm
	Height	167 mm
	Total height	167 mm
Approx. Mass	5.80 kg	
Terminal	M5 threaded post	

### ■Characteristics

Capacity (25 °C)	20 hour rate	20Ah
	10 hour rate	17Ah
	3 hour rate	15Ah
	1 hour rate	12Ah
Internal Resistance (25 °C)	Fully charged battery	15 mΩ
Temperature Dependency of Capacity (20 hour rate)	40 °C	102%
	25 °C	100%
	0 °C	85%
	-15 °C	65%
Self Discharge (25 °C)	After 3 months	91%
	After 6 months	82%
	After 12 months	64%

### ■Duration of discharge vs. discharge current

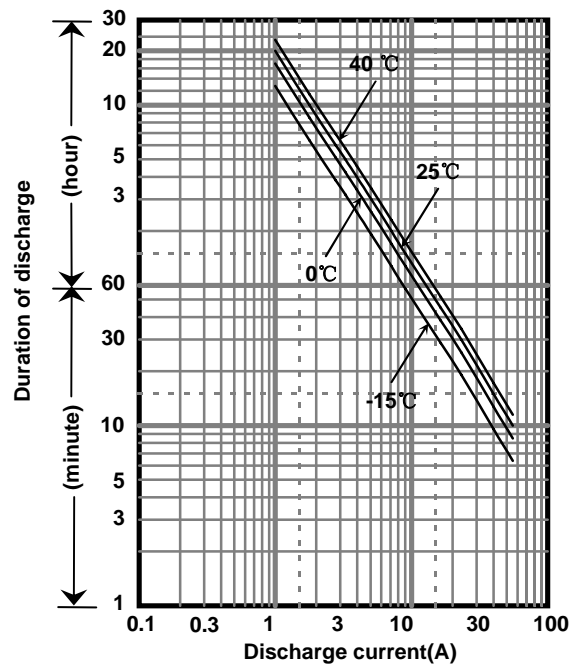

### ■Watt Table(25°C)

Cut-off V	5min	10min	15min	20min	30min	45min	1h	1.5h	2h	3h	4h	5h	6h	10h	20h
9.6V	853	557	425	357	266	188	150	103	83.1	61.9	47.5	39.2	31.5	21.6	11.7
9.9V	800	546	423	351	263	186	148	101	82.5	61.5	47.2	38.9	31.4	21.5	11.7
10.2V	750	532	414	345	260	185	146	99.1	80.3	60.9	46.9	38.6	31.2	21.3	11.6
10.5V	672	493	385	328	254	182	145	97.0	77.5	60.0	46.6	38.3	30.8	21.2	11.6
10.8V	594	440	359	319	246	179	141	94.3	73.9	58.8	46.0	37.4	30.3	21.0	11.5

### ■Ampere Table(25°C)

Cut-off V	5min	10min	15min	20min	30min	45min	1h	1.5h	2h	3h	4h	5h	6h	10h	20h
9.6V	85.0	55.3	40.0	34.2	24.0	16.9	12.7	9.04	6.98	5.17	3.95	3.26	2.61	1.75	1.01
9.9V	79.7	54.2	39.7	33.6	23.7	16.8	12.6	8.86	6.92	5.14	3.93	3.23	2.60	1.75	1.01
10.2V	74.7	52.8	38.9	33.1	23.5	16.6	12.4	8.68	6.74	5.09	3.90	3.20	2.58	1.73	1.00
10.5V	66.9	48.9	36.2	31.4	22.9	16.4	12.2	8.50	6.51	5.01	3.88	3.18	2.55	1.72	1.00
10.8V	59.2	43.6	33.8	30.6	22.2	16.1	12.0	8.27	6.20	4.91	3.82	3.10	2.51	1.70	0.994

All mentioned values are average values

### ■ Charging Method (25°C)

Trickle use	Control voltage:13.6-13.8V Initial current:3.00A or smaller
-------------	--

### ■ Cut off voltage

Discharge current	1.00A-4.00A	4.00A-10.0A	10.0A-20.0A	20.0A-40.0A	40.0A-60.0A
Cut off voltage(V)	10.5	10.2	9.9	9.3	8.7

### ■ Influence of Temperature on Trickle life

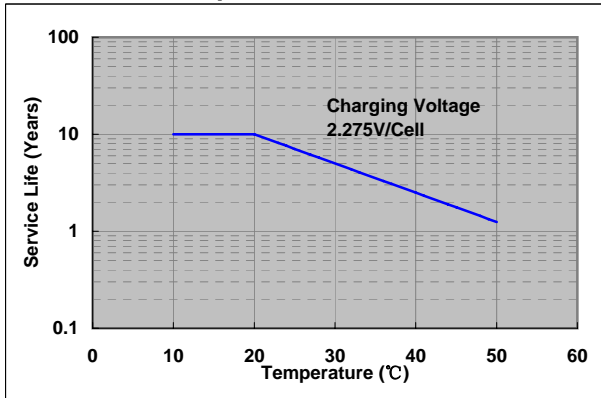

### ■ Residual capacity test result

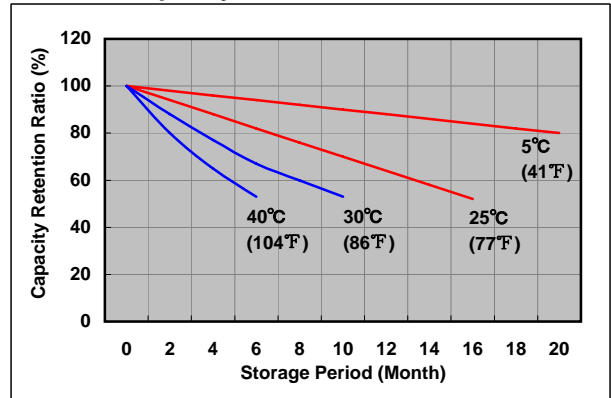

### ■ Constant-voltage constant-current charge characteristics for Trickle use

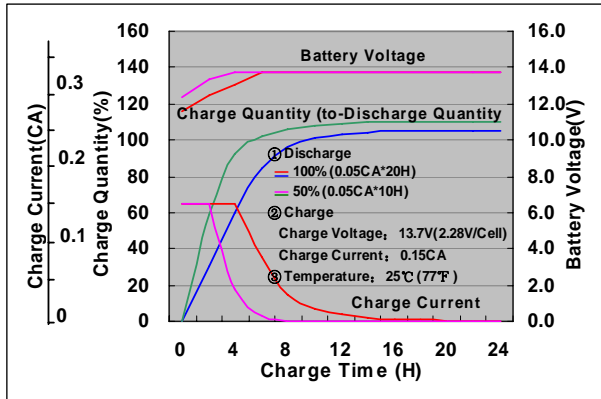

### ■ Discharge capacity by temperature and by discharge current

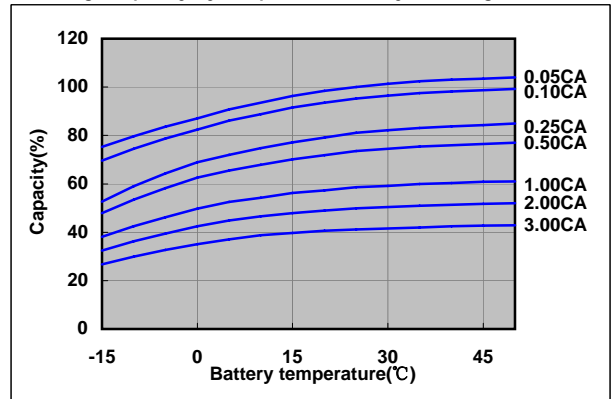

### ■ Discharge characteristics(25°C)

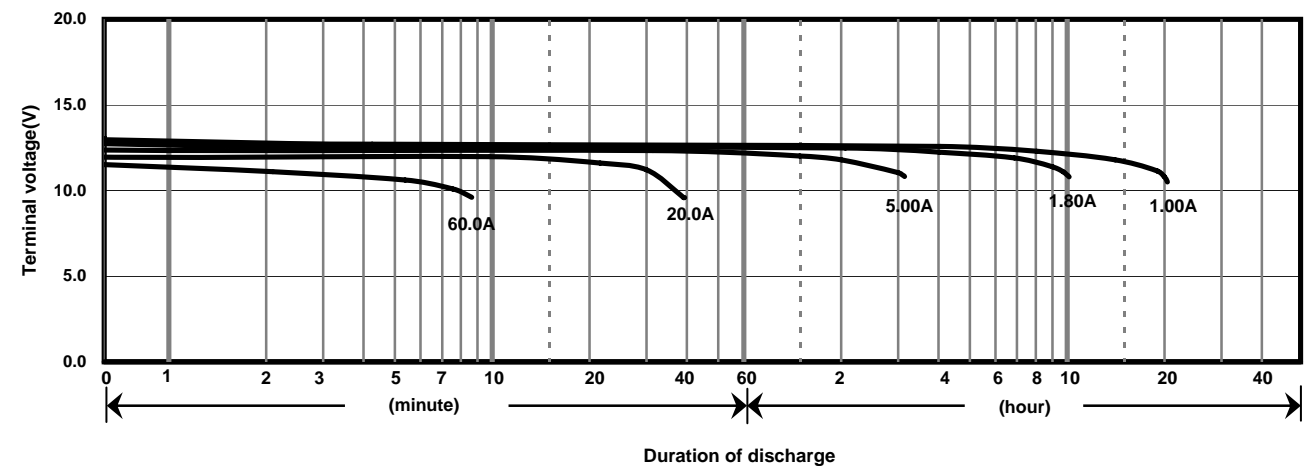

### ⚠ Caution

Due to the potential energy stored in the batteries, Please read 《Precautions for handling the Rechargeable Valve Regulated Lead Acid Batteries》 before using batteries. If improper handling or use of the batteries without understanding 《Precautions for handling the Rechargeable Valve Regulated Lead Acid Batteries》 may result in bodily injury caused by electrolyte leakage, heat generation, or explosion.

## Panasonic Storage Battery (Shenyang) Co., Ltd

NO. 51 Kunminghu Street, Shenyang Economic & Technical Development Zone, 110141 China  
Tel: 86 24 25818921  
Fax: 86 24 62786318  
Website: <http://www.panasonicbattery.cn>

2010.11